

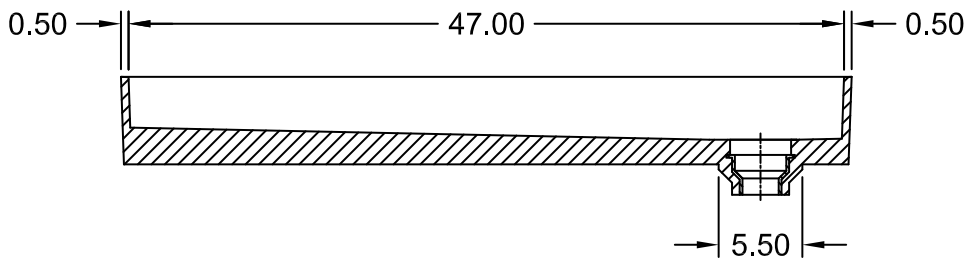

(Not to scale)

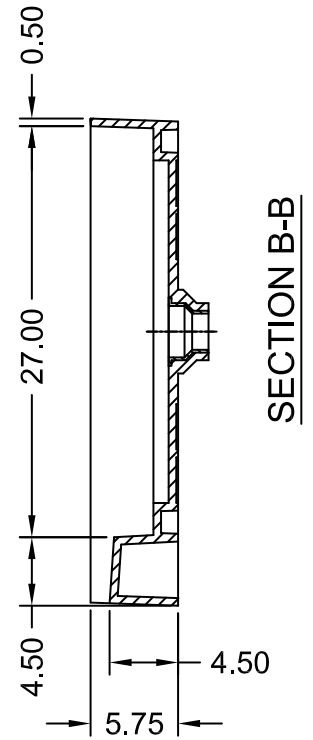
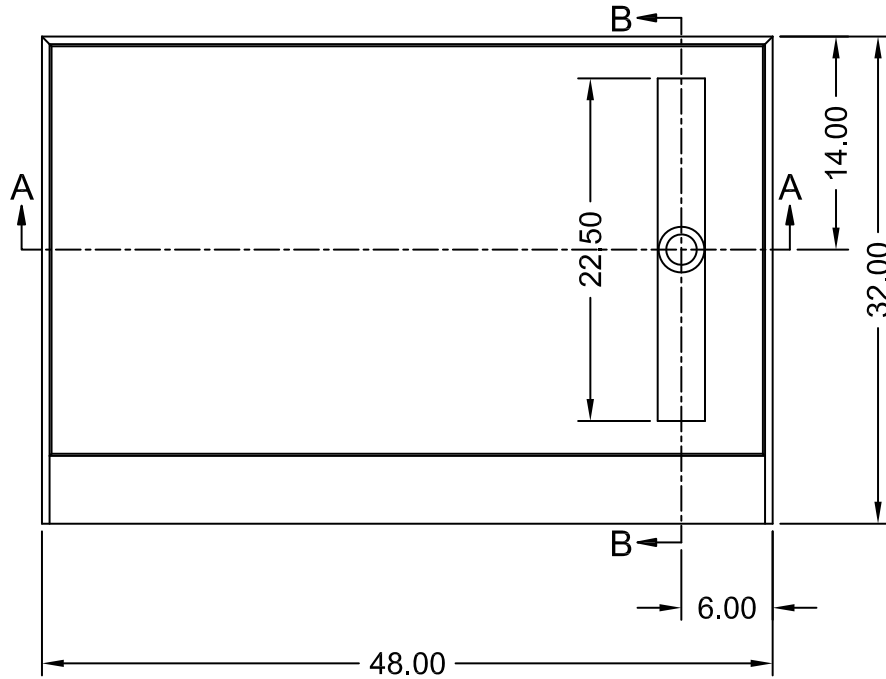

SECTION A-A

Solid surface panel will be pitched and adhered to the shower pan.

	ANSI Z124.1-95	ASTM F462-79	Toll Free 800.232.6156	techsupport@tileredi.com
	ANSI Z124.2-95	B45.0-02	Tel: 954.323.0125	
	ICC/ANSI A117.1.98	B45.5-02	Fax: 954.344.8064	www.tileredi.com
	© 2021 TILE REDI USA, LLC			



2023.05.12