

tile redi[®]

REDI LEDGE[®] - INSTALLATION INSTRUCTIONS

These instructions are exclusively for an RLCorner. If you have purchased an RLRecessed please visit tileredi.com/knowledge-center for the correct instructions.

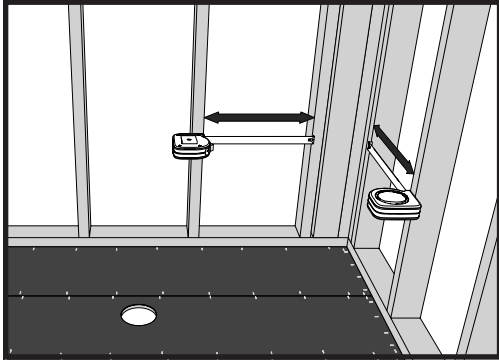

1. The corner of the shower stall where the Redi Ledge will be installed requires stud support. These Redi Ledge stud supports can be made from metal or wood, depending on the project requirements.

Measure the horizontal distance from the corner stud opening to the stud to the left so you can cut and mount your two left side supports. Do the exact measurement again from the corner stud to the stud to the right so you can cut and mount the right stud supports.

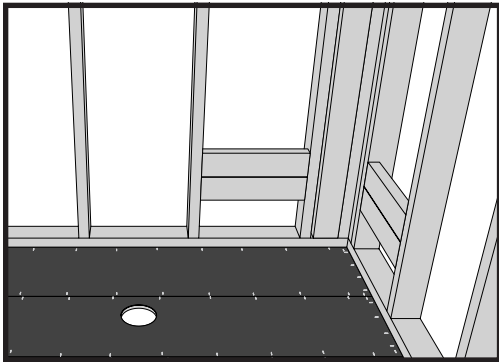

2. Mount the support studs.

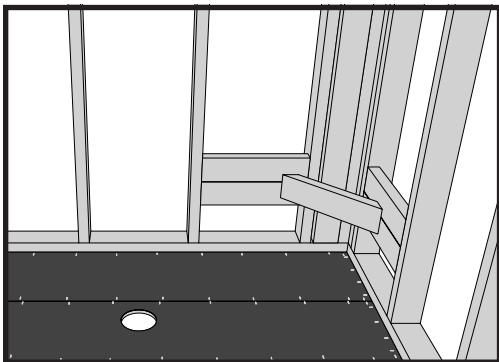

3. Now cut and mount a diagonal support bracket to allow for support to the underside of the Redi Ledge.

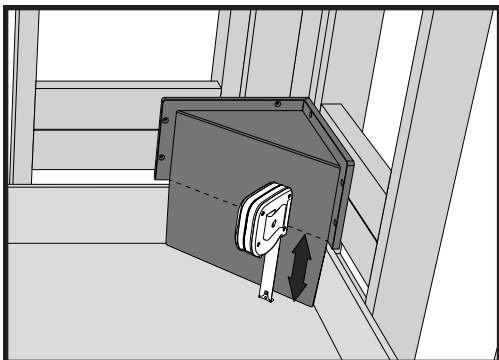

4. Once the shower pan is firmly butted up against the studded walls, measure the distance from the floor of the shower pan corner to the underside of the Redi Ledge. Use that measurement to make any height adjustments to the diagonal stud support so that the Redi Ledge sits on top of the support firmly.

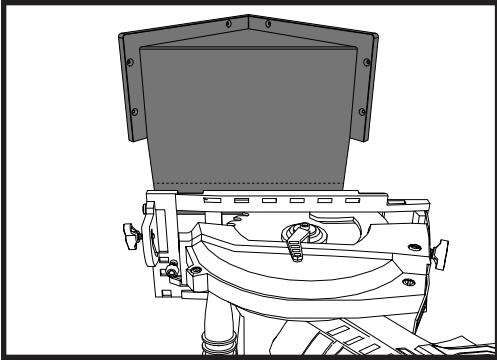

5. It may be necessary to trim the bottom of the Redi Ledge wall so that the Redi Ledge sits flush on the shower pan splash walls. This can be done with a table saw, circular saw, or a reciprocating saw.

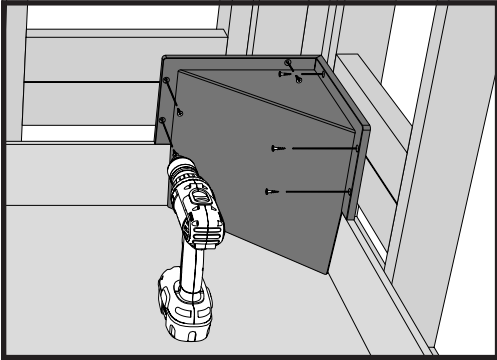

6. Level and mechanically fasten the Redi Ledge using one framing screw in each pre-drilled hole.

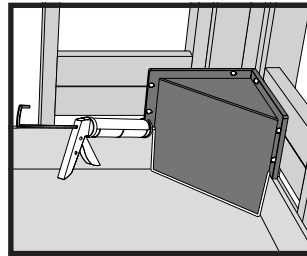

Neatly apply 100% waterproofing silicone to cover each screw head and to fill the gap between the Redi Ledge front, the floor of the shower pan, and the adjacent splash walls.

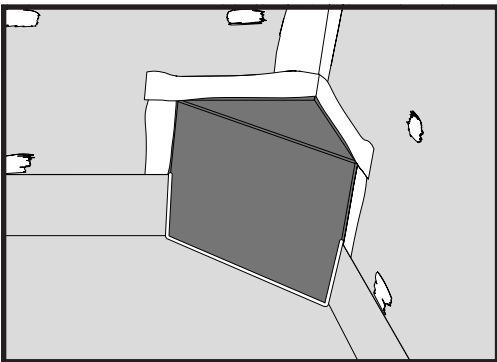

7. Install Redi Wall boards or other shower backer board and waterproofing in accordance with the manufacturers instructions and the standards established by the Tile Council of North America. Seal and waterproof joints between Redi Wall or other backer board and the Redi Ledge using Redi Flash[®], Redi Sealant[™], or 100% silicone. If you are not using Redi Wall and Redi Sealant, it is recommended to use a membrane or liquid applied waterproof product in addition to the Redi Flash or 100% silicone.

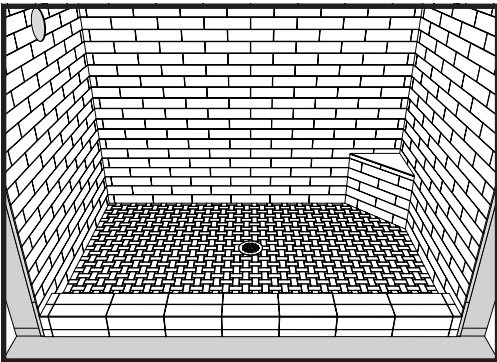

8. Now apply your setting material and set your tile, marble or stone directly to Redi Ledge surface.

436 East 36th Street, Charlotte, NC 28205 | 800.232.6156 | www.tileredi.com | sales@tileredi.com

Tile Redi[®] trademarks and logos are owned by and the Intellectual Property of Tile Redi, LLC.

©2023 Tile Redi, LLC. All Rights Reserved. PATENT: www.TileRedi.com/PatentMarkings