

tile redi.

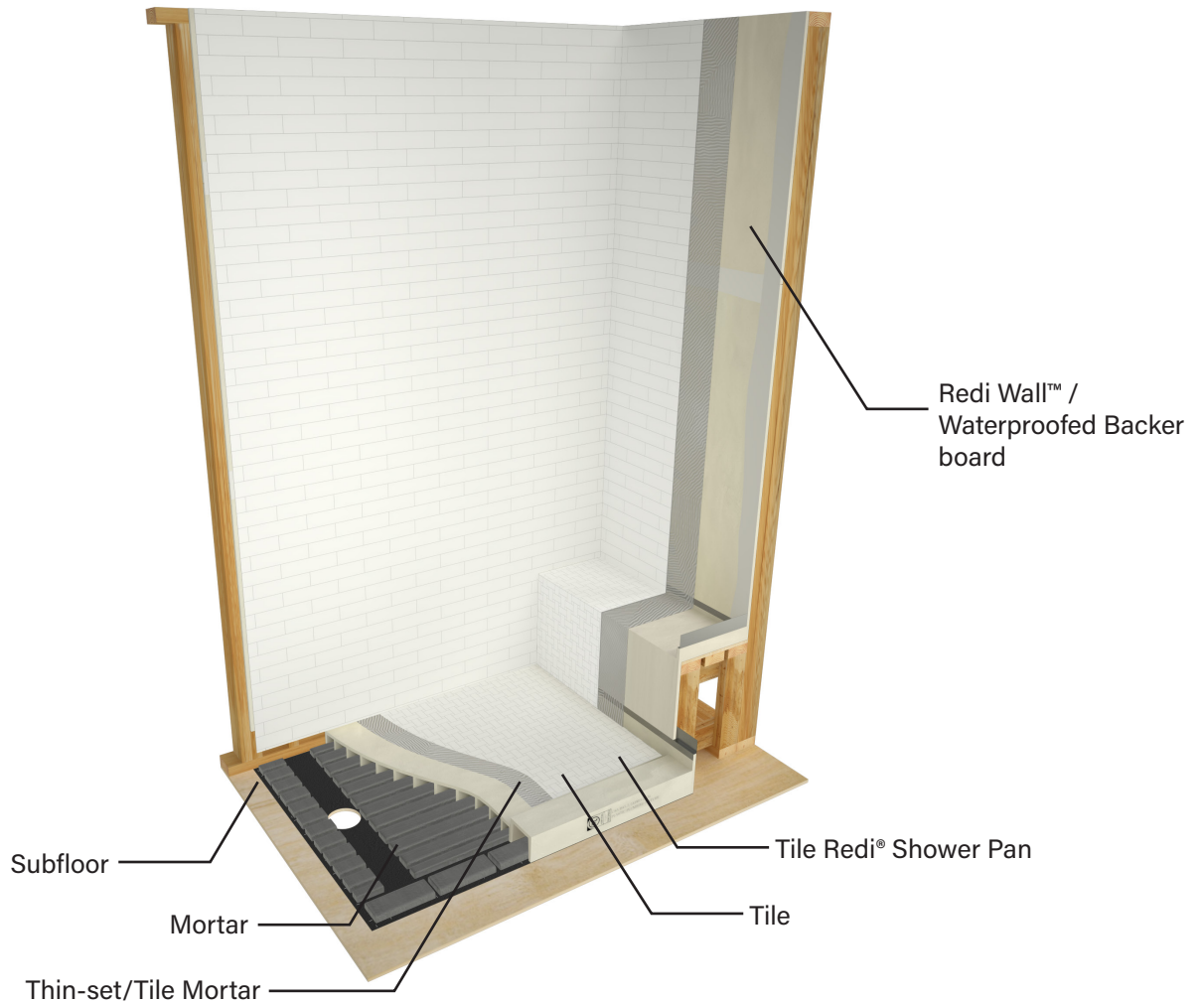

BASE'N BENCH® - INSTALLATION INSTRUCTIONS

The Redi Bench® is designed to be installed exclusively with Tile Redi® shower pans (known as Redi Base®, Redi Trench®, Wonder Drain®, WonderFall Trench®, Bathtub Replacement™, Redi Free®, and Redi Your Way®) using the Redi Flash® flashing system.



TOOLS REQUIRED

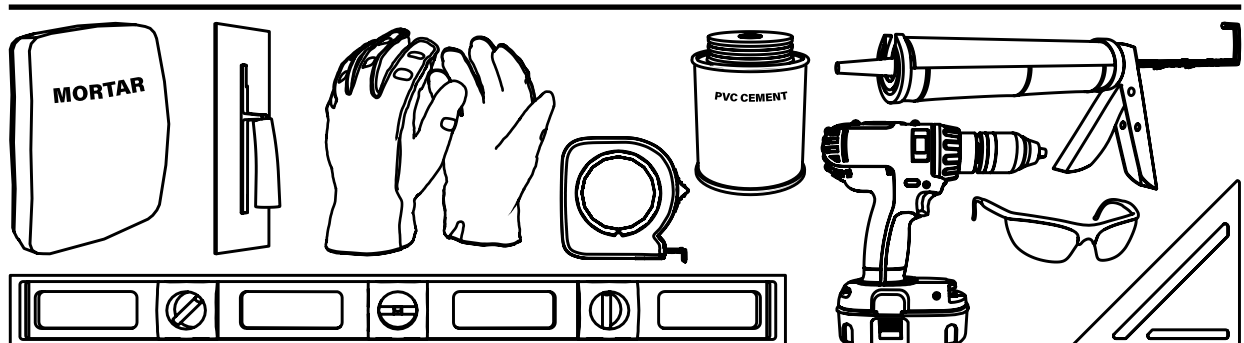

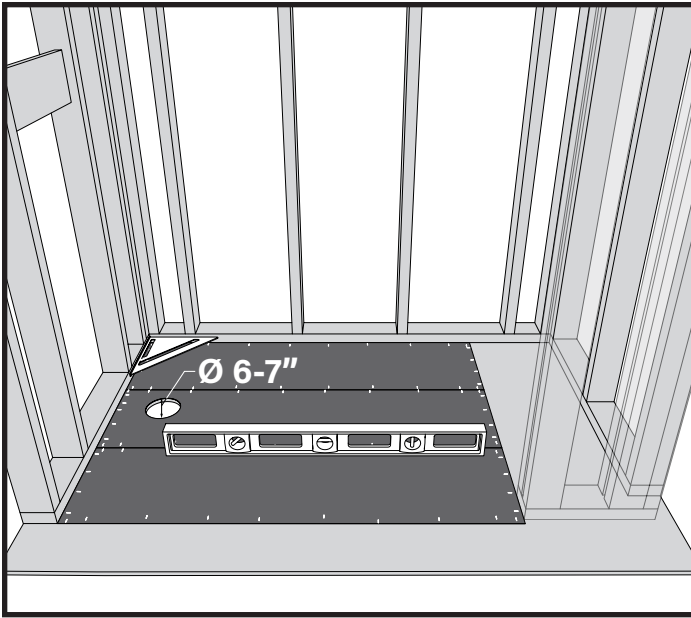

1. The shower stall will need to be framed out as an assembly of the Redi Bench and the Tile Redi shower base, with the framed out opening equal to the outside dimensions of the shower base plus an additional 12 inches on the side of the shower base where the Redi Bench is to be installed to accommodate the depth of the Redi Bench. The bore hole needs to be a minimum 6", but not more than 7" diameter opening*. Ensure that the shower pan subfloor is level, and that the walls are level, plumb, and square. Place the square in the corners to ensure they are square and straight.

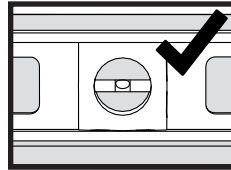

All walls and framing must be plumb prior to proceeding. The floor must be level within 3/8". Sweep up any debris from subfloor.

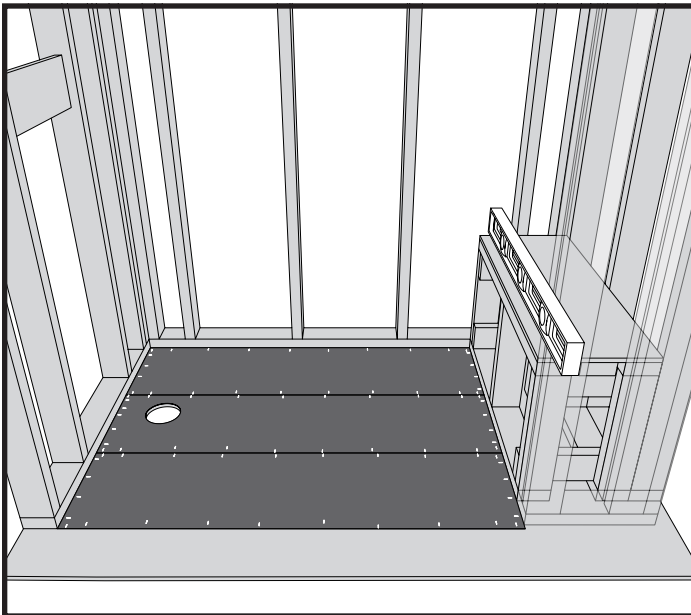

2. Install the Redi Bench frame between the shower base footprint and the shower wall framing. Either wood or metal framing may be used as required by local building codes. The Redi Bench framing (the framing height is based on personal preference, but it is usually a height of 18") should be installed along the appropriate side of the shower base so that it will be butted up against the splash wall of the shower base. The bench framing will then need to be securely attached to the shower floor substrate, and the shower framing on the three sides of the Redi Bench. The Redi Bench framing will need to be level because the Redi Bench is already designed with a slope so the seat of the bench will drain into the shower.

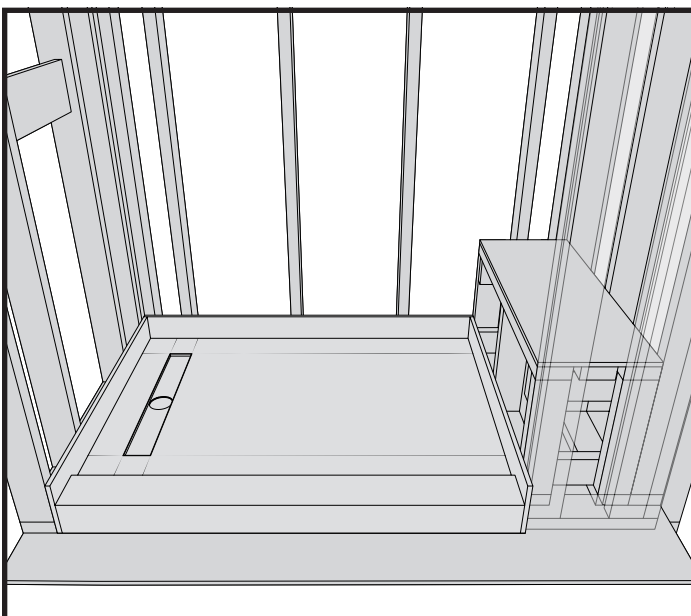

3. To ensure a perfect fit, test fit shower pan drain housing into subfloor bore hole. Make sure the shower pan is aligned properly and fits snugly against the shower frame studs on all sides and corners. Ensure that the pan is level on the floor. There should be no movement or bulge.

DO NOT NAIL OR SCREW INTO THE PAN. DO NOT SAND, CUT, OR MAKE ANY CHANGES/ MODIFICATIONS TO THE SURFACE OF THE SHOWER PAN WHATSOEVER.

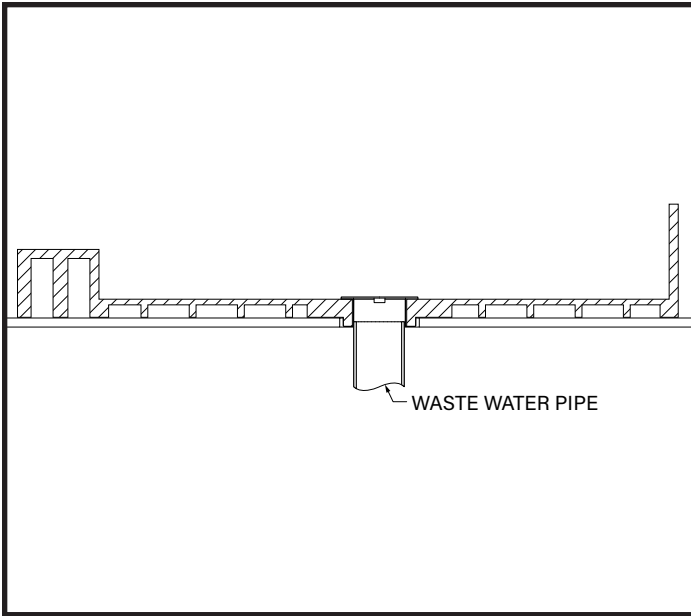

4. This step depends on whether there is access to the drain connection from below the subfloor:
- If there is access from the subfloor below, then cut a section of drain pipe (PVC, as applicable to the type of drain) which is long enough to extend below the subfloor and easily make a connection to the waste water pipe.
 - If there is no access from the subfloor below, then make sure the drain pipe stubbed up from the subfloor is adjusted to a height sufficient to fit properly into the shower pan drain connection.

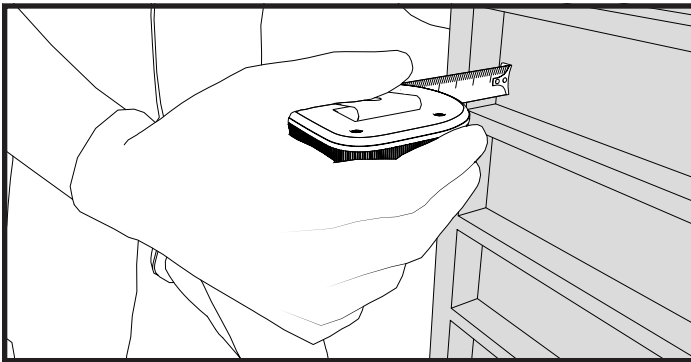

5. Turn the shower pan over and note that there are ribs under the shower pan floor. To calculate the amount of mortar needed, you will need to know the depth of the deepest point in between the ribs. Once you have that value, calculate the thickness (depth) of your mortar base (Type N or S Mortar) using the following formula:

Redi Trench® / WonderFall Trench® / Redi Free® Trench Pans: See Step 5 image for mortar thickness for Trench pans.

Redi Base® / Redi Free® (Non-Trench) Pans: (Left or Right Drain ONLY) Subtract 1/4" from deepest rib measured in Step 5.

Redi Base® / Wonder Drain® / Redi Free® (Non-Trench) Pans (Center Drain ONLY): Subtract 1/8" from deepest rib measured, PROVIDED that the mortar base should always be at least 1/2"

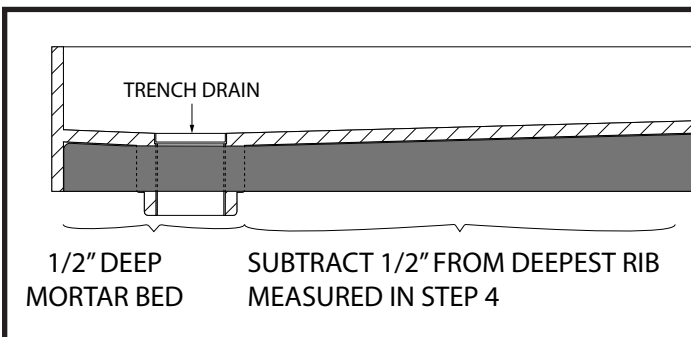

DO NOT PLACE THE MORTAR DIRECTLY ON A WOOD OR GYP-CRETE SUBSTRATE. FIRST, WATERPROOF THE WOOD SUBSTRATE WITH A FLUID APPLIED WATERPROOFING MEMBRANE, OR NO. 15 OR NO. 30 ROOFING PAPER SO THE WOOD DOES NOT ABSORB THE WATER FROM THE MORTAR.

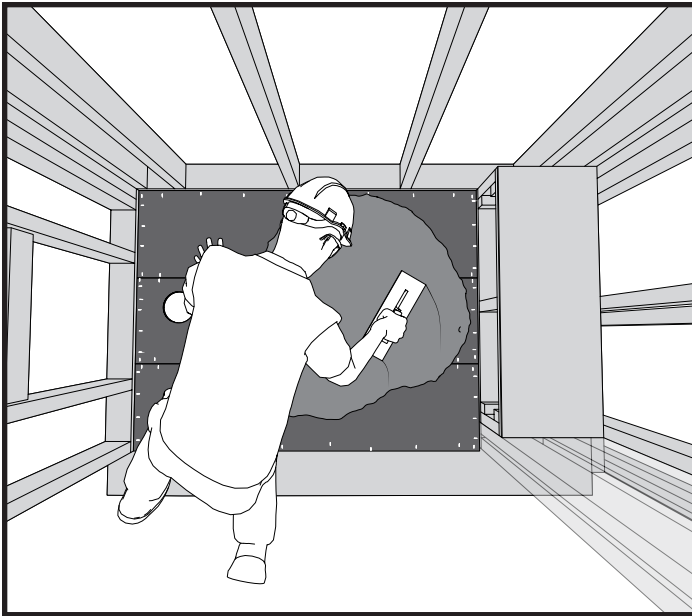

6. Spread your mortar base (should be a milk shake consistency), evenly across the subfloor at the thickness calculated in Step 5.

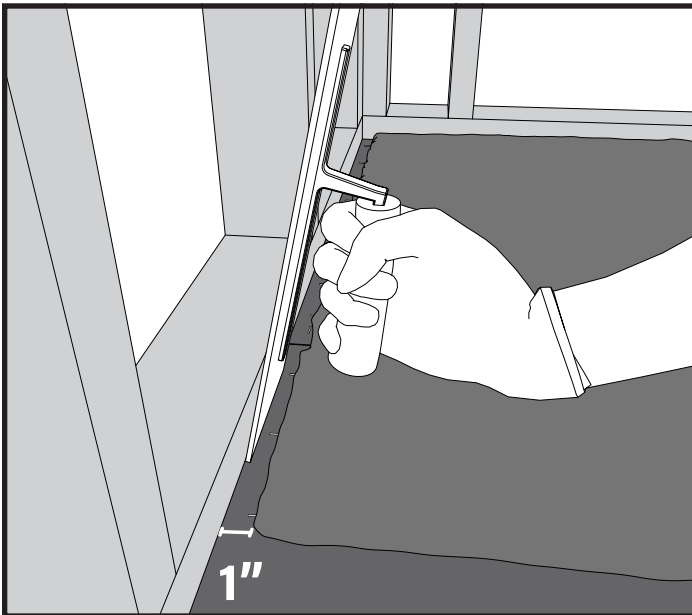

7. Offset the mortar base 1" from each outside edge of the pan with exception of the curb side. Mortar will protrude out from under the curb, run the finishing trowel along curb face to backfill any excess mortar.

Mark a line on a shim denoting the distance calculated in Step 5. Use the shim as a depth gauge to verify that the mortar bed is the depth you need.

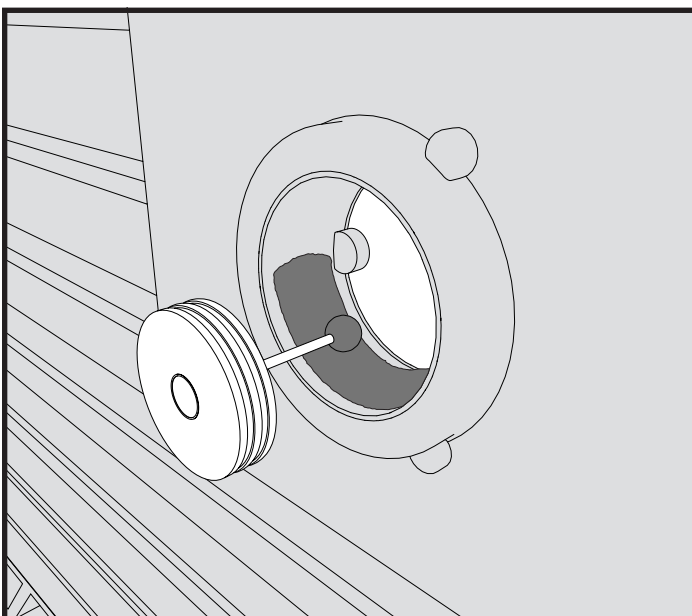
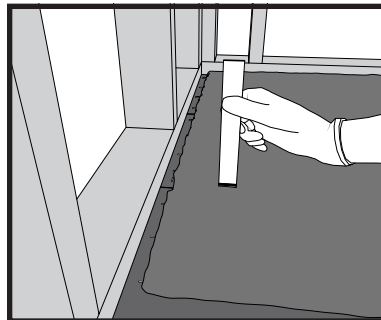

8. If there is access from the subfloor below and you followed Step 3a, then brush primer and PVC adhesive on the inside of the drain and outside of the cut drain pipe and quickly insert into drain connection, then be sure the drain pipe extends far enough below the subfloor so it can be connected to the waste water pipe following the installation.

If there is no access from the subfloor below and you followed step 3b, then brush primer and PVC adhesive on the drain pipe stubbed up from the subfloor, then quickly insert the stubbed-up drain pipe properly into the shower pan drain.**

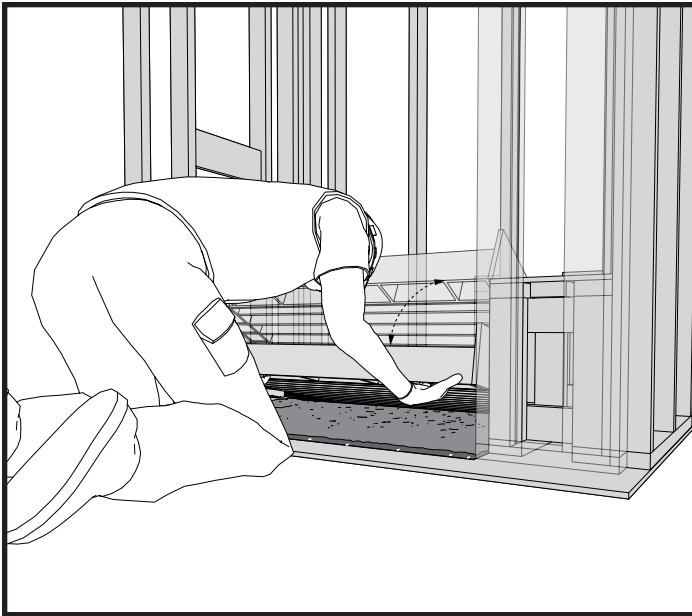

9. Place the pan in the mud base and firmly but gently shimmy the pan (applying pressure in drain location first) into the mud so that (i) the drain is fully supported by mud at the bore hole in the substrate, and (ii) the ribs are completely filled with the mud alternately applying hand pressure to the right and left sides of the pan floor until the pan ribs come within 1/8" clearance of the subfloor.

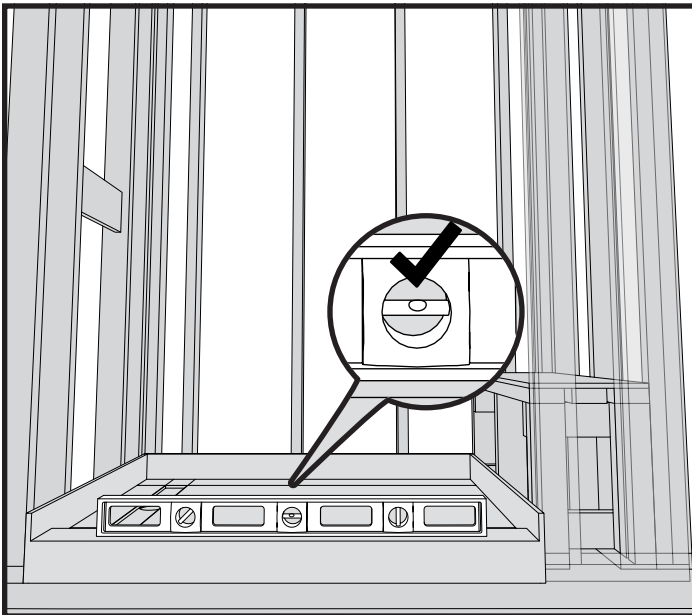
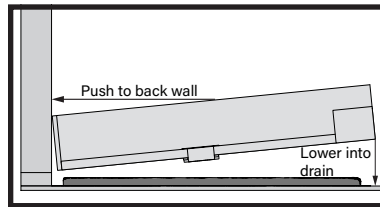

10. Using the level, ensure that the pan is level left to right, and front to back along the splash walls. Also make sure the pan is level left to right along the curb. Allow the mortar bed to dry in accordance with the instructions of mortar manufacturer.

DO NOT USE THE INSIDE OF THE PAN AS AN INDICATOR SINCE THE PAN IS PRE-PITCHED. DO NOT STEP INTO THE SHOWER PAN ONCE THE SHOWER PAN HAS BEEN SET AND LEVELED UNTIL THE MORTAR HAS CURED COMPLETELY.

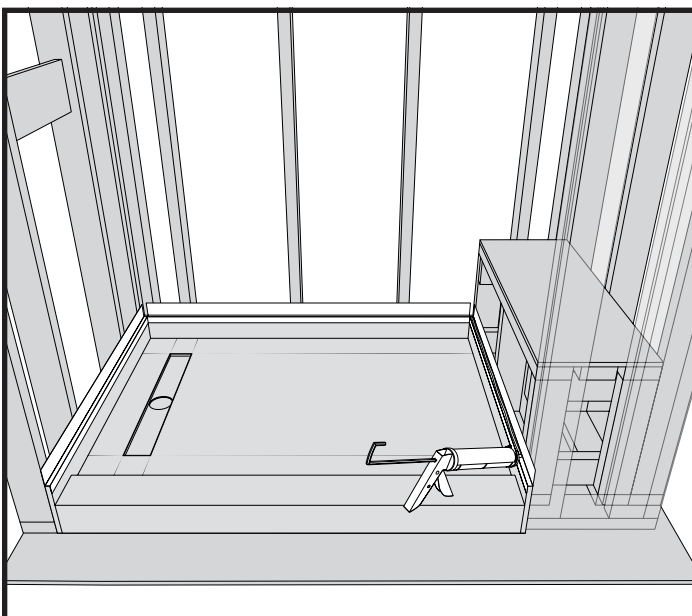
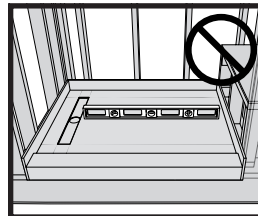

11. Install the Redi Flash flashing system along the splash walls of the shower pan. Apply a bead of 100% silicone to the top of the Redi Flash flashing that runs along the splash wall alongside the bench frame.

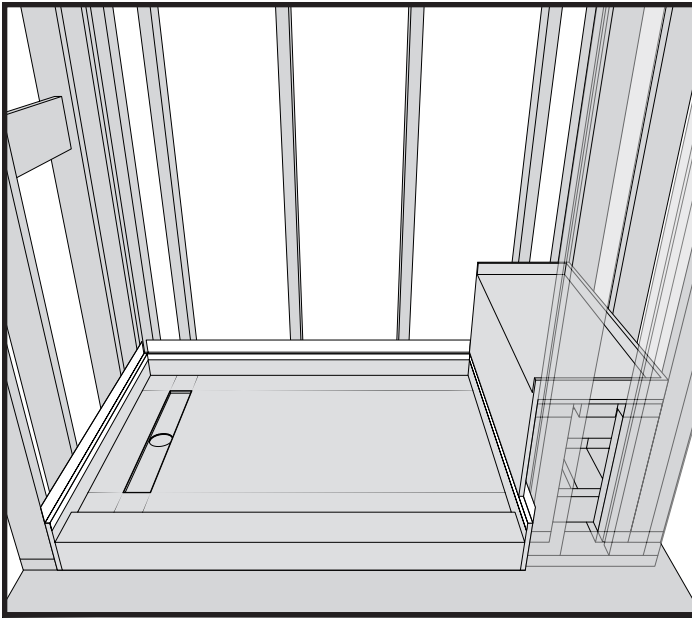

12. Apply Loctite PL Premium construction adhesive to all surfaces of the bench frame which are in contact with the Redi Bench when it is placed in the frame (i.e., the top of the frame and the vertical frame studs above the splash wall.) Then, install the Redi Bench by securely placing the Redi Bench on the framing so it is in contact with all the seat and leg support areas containing Loctite PL Premium construction adhesive. Press the Redi Bench firmly onto the Loctite PL Premium construction adhesive on the bench frame and hold it securely in place for approximately 30 minutes. After placing the bench frame wipe clean any excess silicone.

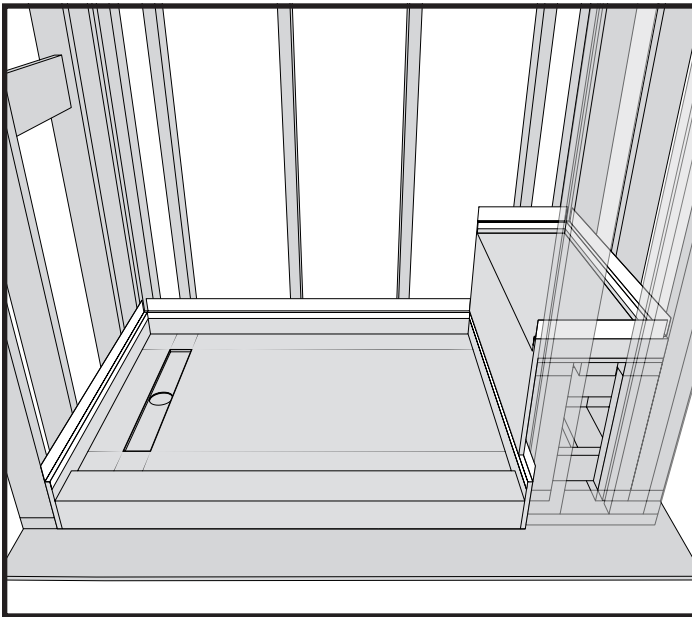

13. Install the Redi Flash on the top of the 3 splash walls of the Redi Bench in the same fashion that the Redi Flash was installed on the shower base splash walls.

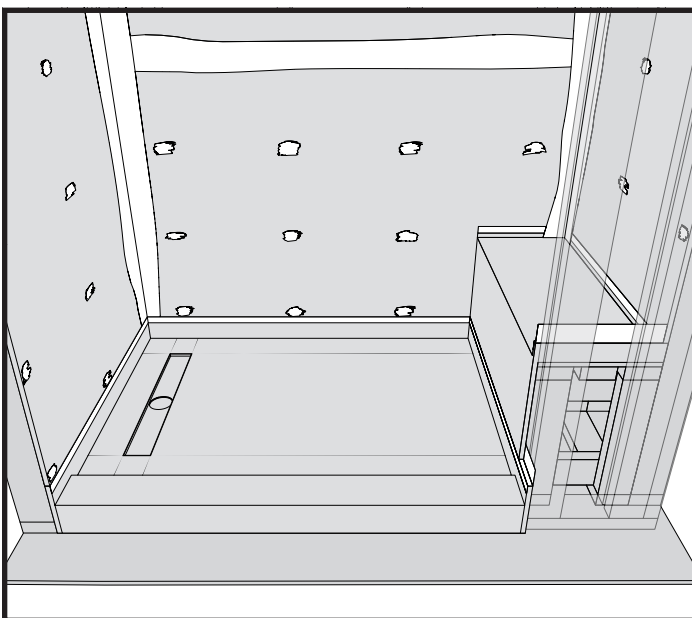

14. Install Redi Wall boards or other shower backer board and water proofing in accordance with the manufacturers instructions and the standards established by the Tile Council of North America. Seal and waterproof joints between Redi Wall or other backer board and the shower pan splash walls using Redi Flash®, Redi Sealant™, or 100% silicone. If you are not using Redi Wall and Redi Sealant, it is recommended to use a membrane or liquid applied waterproof product in addition to the Redi Flash or 100% silicone. Allow the mortar bed to dry in accordance with the instructions of mortar manufacturer prior to wall system installation.

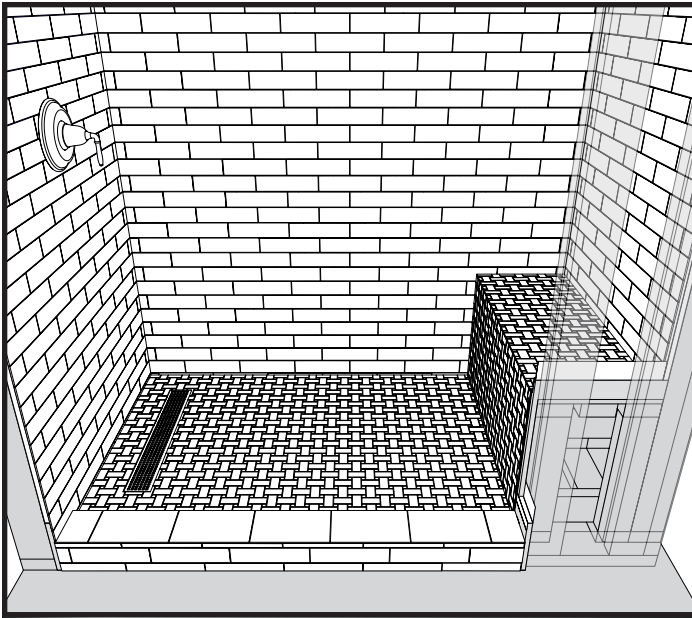

15. Adjust the height of the drain as necessary to accommodate the floor covering. Set your tile using a white modified thin-set/tile mortar and a notched trowel as specified by the thin-set/tile mortar manufacturer based on your tile size. Tile Redi recommends the modified thin-set/tile mortar products found in table below.

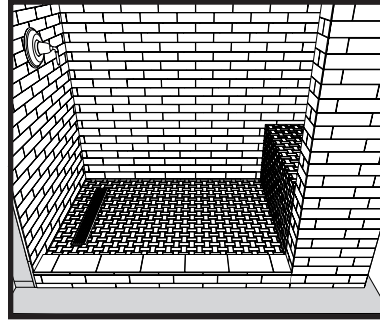

Tile the rest of the shower.

Tile Redi Approved Modified Thin-sets/Tile Mortars		
MAPEI Ultraflex LHT White	MAPEI Large Format Floor and Wall White	CBP Prolite White
MAPEI Ultraflex 1 White	MAPEI Porcelain Tile White	CBP Flexbond White
MAPEI Large Tile and Stone White	MAPEI Ultraflex LFT White	TEC Ultimate 6 Plus 487 White

! CALIFORNIA PROP 65 WARNING: This product contains one or more chemicals, including Chromium, known to the State of California to cause cancer and birth defects or other reproductive harm. For more information go to www.P65Warnings.ca.gov

436 East 36th Street, Charlotte, NC 28205
800.232.6156 | sales@tileredi.com

www.tileredi.com

Tile Redi® trademarks and logos are owned by and the Intellectual Property of Tile Redi, LLC.
©2023 Tile Redi, LLC. All Rights Reserved.

PATENT: www.TileRedi.com/PatentMarkings